

# AIRFLO®

## INSTRUCTION MANUAL



### Bagless Vacuum

model AFV3808

## IMPORTANT SAFETY REMINDERS

- This appliance should be for domestic use only, as described in this users' guide. Please ensure that this manual is fully understood before using the appliance.
- This appliance is not intended for use by persons (including children) with reduced physical, sensory or mental capabilities, or lack of experience and knowledge, unless they have been given supervision or instruction concerning use of the appliance by a person responsible for their safety. Children should be supervised to ensure that they do not play with the appliance.
- To ensure the continued safe and efficient operation of this appliance, we recommend that any servicing or repairs are only carried out by an authorised service agent.
- Power off before unplugging from electrical outlet. Unplug the electrical cord when not in use and before servicing. Do not touch plug or vacuum with wet hands.
- To reduce the risk of electric shock, do not use outdoors or on wet surfaces.
- The use of accessory attachments not recommended by the appliance manufacturer may cause injuries.
- Do not leave the appliance unattended while in use.
- To protect against electric shock, do not immerse cords, plugs or appliances in water or any other liquid.
- This appliance is not intended to be operated by means of an external timer or separate remote-control system.
- Do not use this appliance to pick up flammable or combustible liquids such as gasoline.
- Do not allow cord to touch hot surfaces. Use extra care when cleaning on stairs. Do not run appliance over cord.
- Do not pick up anything that is burning or smoking such as cigarettes, matches or hot ashes.

- Store your appliance indoors in a cool, dry area.
  - Do not operate the appliance with a damaged cord or plug or after the appliance has been damaged in any manner.
  - Do not unplug by pulling on cord. To unplug, grasp the plug, not the cord.
  - Do not handle plug or vacuum cleaner with wet hands.
  - Do not put any object into openings. Do not use with any opening blocked.
  - Keep free of dust, lint, hair or anything that may reduce air flow.
  - Keep hair, loose clothing, fingers and all parts of body away from openings and moving parts.
  - Turn all controls off before unplugging.
  - Hold plug when rewinding onto cord reel. Do not allow plug to whip when rewinding.
  - Unplug before connecting the hose
  - Do not use without dust bag and/or filter in place.
- Damage caused by noncompliance with these instructions or any other improper use or mishandling will forfeit the appliance's warranty.

## PARTS

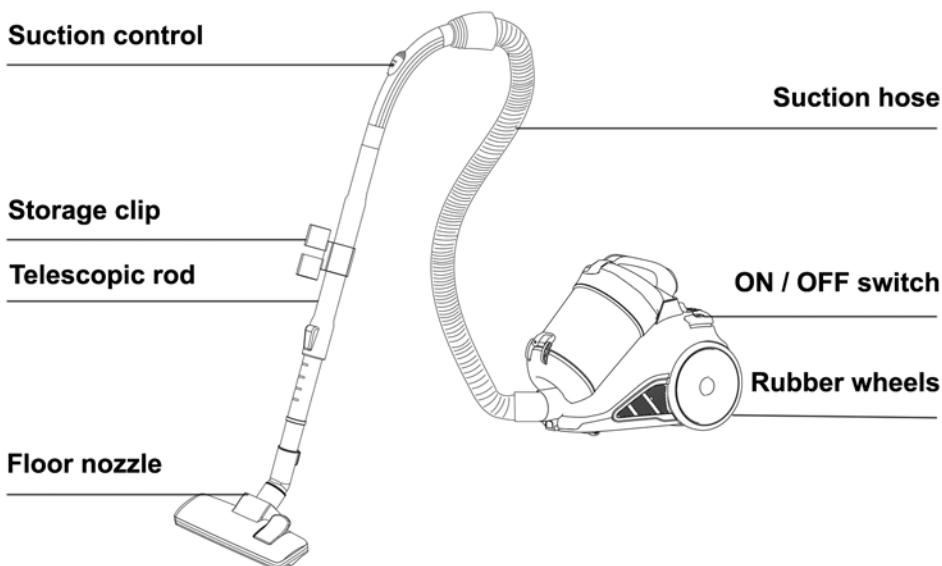

## UNIT ASSEMBLY

- **Rod**

1. Insert the rod in the air intake opening.
2. Push the rod in until it locks in place



*To disassemble:*

1. Take the rod from the air intake after disconnecting from the mains socket.

- **Accessories**

1. Set the telescopic rod to the correct length
2. Push the rod forward and pull out the lower part of the extension to the length required. Let it snap into place.

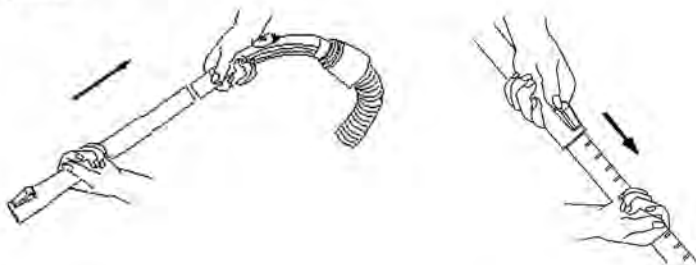

3. Fix the floor brush to the telescopic rod.

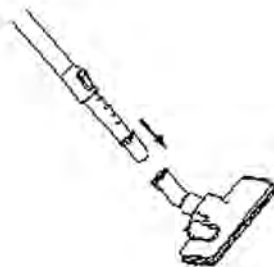

\*\*\* Floor nozzle settings:

- A. Hard floors = brush bar extended
- B. Carpets = brush bar retracted

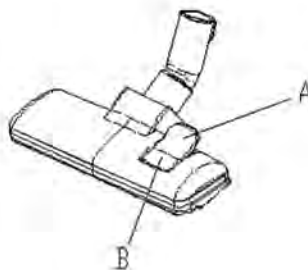

\*\* other accessories include:

Upholstery nozzle



Furniture brush





## HOW TO USE YOUR VACUUM

- Before using the device, roll out a sufficient length of your vacuum's electric flex cable and plug into the mains socket.

The yellow mark on the electric flex cable is the maximum length that must not be exceeded.



To switch on the device, press the foot pedal button .

- To rewind the cable, press the button  with one hand and guide the cable with the other hand to ensure that it does not whip causing damage.

## Regulating the suction power

You can set the suction power on the device as you require it using the Variable Suction Control. (Fig. 1)

It's recommended to use minimum suction power for delicate materials.

Select medium suction power for mattresses, upholstered furniture and carpets. Select maximum suction power for tiles, wood and other robust floors.

\*\* you can also use the suction control in the telescopic rod (Fig. 2) to lessen the vacuum's suction power.



Fig. 1

## Variable suction control

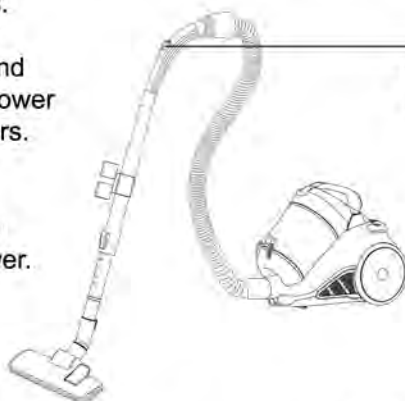

## Suction control

Fig. 2

## Emptying the dust container

1. Switch off the vacuum cleaner and disconnect the plug from the mains. (Pull on the plug, not on the cable.)
2. Pull out the dust container by pushing the release button on the carrier handle (Fig. 3). Lift out the dust container and carry it to the waste bin.
3. A button is located on the dust container that you can use to open and automatically empty the dust container (bottom-down technology).

## release button



Fig. 3

To do this, hold the dust container over your dust bin and press on the empty button (Fig. 4).

4. After emptying it, clean the HEPA filter if necessary (see Cleaning the HEPA filter on page 7).
5. Push the HEPA filter cleaning system back into position until it snaps into place. Your vacuum cleaner is now ready to use again.



Fig. 4

- If suction does not seem to reach the max, open the dust cup and check if there is blockage. Clean it up immediately.

### **Cleaning the Micro and Sponge Filters**

The Micro and Sponge Filters should be cleaned regularly. Cleaning is best done when emptying the dust container.

1. Switch off the vacuum cleaner and disconnect the plug from the mains. (Pull on the plug, not on the cable.)
2. Pull out the dust container by pushing the release button on the carrier handle.

3. Take out the micro filter and then take out the sponge filter.

4. Rinse the sponge filter under running water and allow it to dry.

5. Remove any dust off the micro filter.



6. Place the micro and sponge filters back into the dust container until it snaps into place.

### **Cleaning the HEPA filter**

1. Switch off the vacuum cleaner and disconnect the plug from the mains. (Pull on the plug, not on the cable.)

2. Open the exhaust air grill (located at the rear of the vacuum cleaner).

3. Take out the HEPA filter and rinse under cold running water and allow dry.

4. Put the HEPA filter back into place and place in the grill.

5. Close the exhaust air filter grill.

