

AIRFLO[®]

INSTRUCTION MANUAL

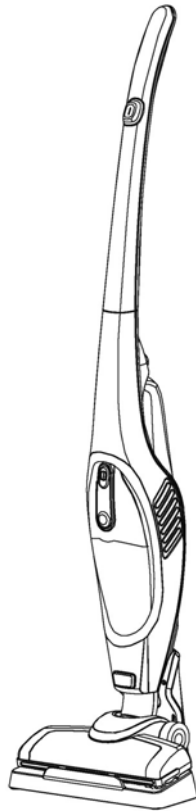

2-in-1 Power Vac

Model AFV612/614

IMPORTANT SAFETY REMINDERS

1. Before using this appliance, check that the mains power voltage corresponds to the voltage shown on the rating label.
2. Do not use the appliance to vacuum water and other liquids; lighted stub, hot ashes and other combustible things; sharp objects; wood pieces, cement, calcimine and the like.
3. Keep the vacuum cleaner away from stoves and heat-emitting appliance. Heat can deform and discolor the plastic parts of unit.
4. Always remove the plug from the power socket when the appliance is not charging.
5. Never use spirits or other solvents to clean the appliance.
6. Never leave the appliance unattended when it is switched on. Keep the appliance out of the reach of children or the infirm.
7. Do not switch the appliance on if it appears to be faulty in any way.
8. The battery must be removed from the appliance before it is scrapped.
9. The battery is to be disposed of safely.
10. The appliance must be disconnected from the supply when removing the battery.
11. Only the adapter provided by the manufacturer can be used.
12. This appliance is not intended for use by persons (including children) with reduced physical, sensory or mental capabilities, or lack of experience and knowledge, unless they have been given supervision or instruction concerning use of the appliance by a person responsible for their safety. Children should be supervised to ensure that they do not play with the appliance.
13. This appliance is for domestic use only.

PARTS

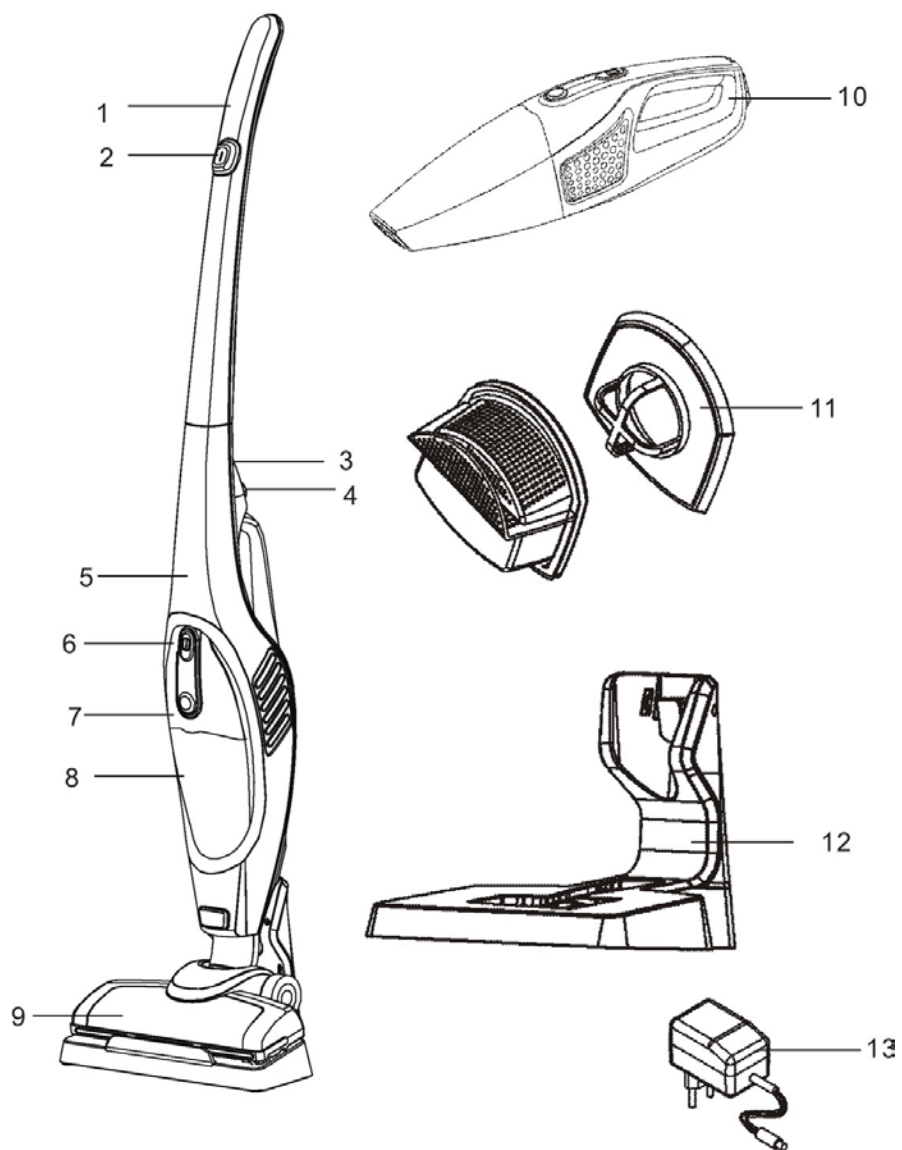

1. Handle

2. Power switch

3. Set screw

4. Handheld vac
release button

5. Body

6. Handheld switch

7. Dust barrel release button

8. Dust barrel

9. Motor brush

10. Handheld vac

11. Filter

12. Charger / Base

13. Adapter

ASSEMBLY

Main unit

Connect the handle to the body.

Put a screw in to hold the two together.

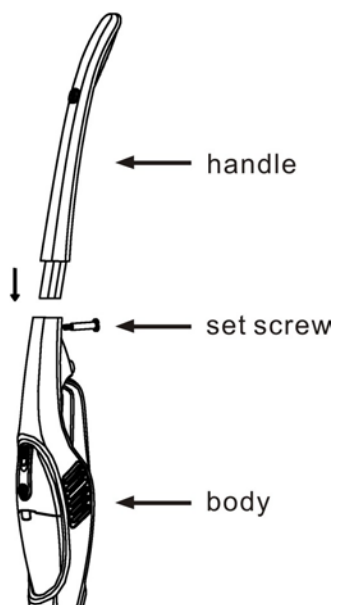

Motor brush

Connect the motor brush to the body until it clicks into position.

To remove the motor brush, press the knob and pull to remove the brush from the body.

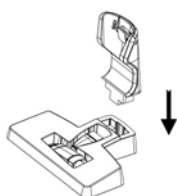
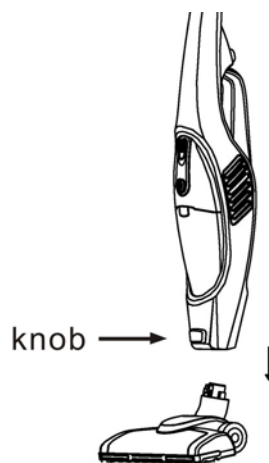

Charger / Base

Fit the back into the charge base

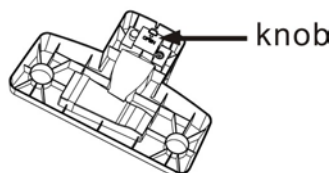

Remove the back from the charger base. Press the knob at the bottom of the base and pull out the back.

NOTES ON INSTALLING

*** When using the machine, make sure the filter is installed.

1. Press the handheld vac release button.
2. Remove the handheld vac.
3. Press the dust barrel release button.
4. Remove the dust barrel.
5. Check the filter if it's inside.
6. Re-install the dust barrel.



Figure 1

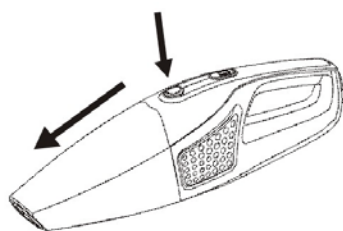

Figure 2

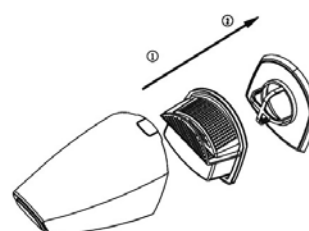

Figure 3

HOW TO USE

1. When the battery is fully charged, the machine is ready to use.
(Before first use, ensure that the machine has been charged for 8 hours).
 - Handheld vac is best for vacuuming sofas, beds, curtains, etc.
 - The main vac is best for floors and carpets.
2. If after 15 minutes the suction power significantly weakens, be sure to shut down and charge up.

CHARGING

1. Turn the switch off.
2. Place the body on the charger base.
3. Connect the adapter to a power outlet.

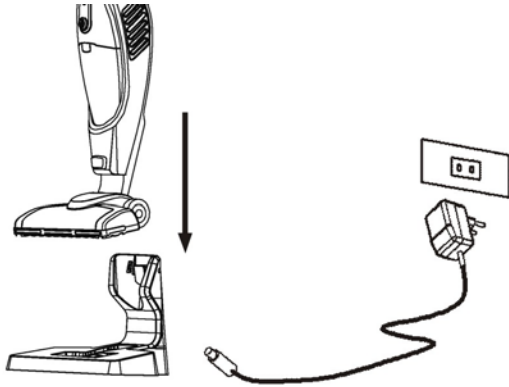

MAINTENANCE

Filter replacement and cleaning

1. Press the handheld release button and remove the handheld.
2. Press the dust barrel release button and remove the dust barrel.
3. Take out the filter and empty the dirt inside.
4. Clean the filter in water then wait for it to dry completely.
5. Place the filter back into the dust barrel.
6. Put the dust barrel back into the handheld.

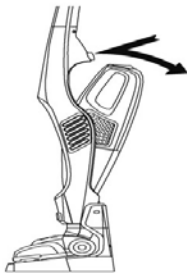

Figure 1

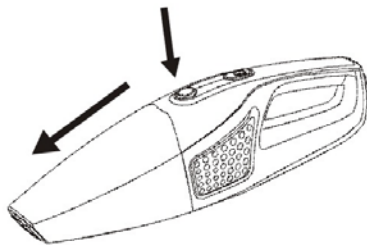

Figure 2

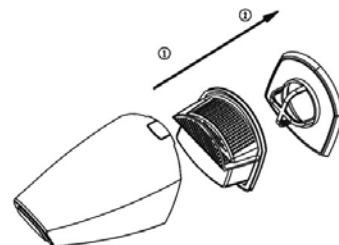

Figure 3

Rotating brush cleaning

1. Turn the brush bottom screw to unlock position (see photo below)
2. Open the brush bottom fixed device.
3. Clean the rotating brush.
4. Put the rotating brush back.
5. Turn the brush bottom screw to lock position.

